

Brochure

VIAVI

OSA-500RS Testing Solution

xWDM Spectral Testing Just Got Easier,
Faster, and More Reliable

Operators globally are under increasing pressure to add more and more bandwidth with continuously shrinking budgets, while providing the best customer experience.

The VIAVI OSA-500RS accurately validates optical performance under extreme conditions as networks are continually pushed to higher levels and ROADMs are added for uninterrupted service.

The OSA-500RS delivers highly valuable benefits to operators and NEMs who commission, install, upgrade, or troubleshoot anywhere within the fiber network ecosystem.

T-BERD/MTS-8000 Scalable Multitest Platform

VIAVI offers a wide range of OSA modules for its T-BERD®/MTS family of multi-application platforms. The T-BERD/MTS-8000 is the world's most scalable test platform for next-generation high-speed network deployment (40 G and 100 G) and offers physical, optical, and transport/Ethernet testing capabilities.



Key Benefits

- Improve field operations by getting true in-band OSNR results 40% quicker
- Ensure results reliability with:
 - the industry's most accurate measurements for any xWDM or ROADM network
 - guaranteed wavelength calibration for life that cuts maintenance costs in half
- Transform any technician immediately into an OSA expert with automated tests and pass/fail analysis at the push of a button.
- Use one flexible, universal tool to test any type of xWDM/ROADM network.

Applications

- Deploy and maintain DWDM Metro and Core networks
- Provision and troubleshoot ROADM networks
- Install and maintain CWDM systems in CATV, Access, and Mobile Backhaul
- Test 40 G and 100 G interfaces and networks
- Perform spectral tests on optical components

The Universal OSA-500RS Can Do It All

Buy Fewer Test Tools and Lower your CapEx

For technical crews who use these applications:

Provisioning and Troubleshooting ROADMs Networks

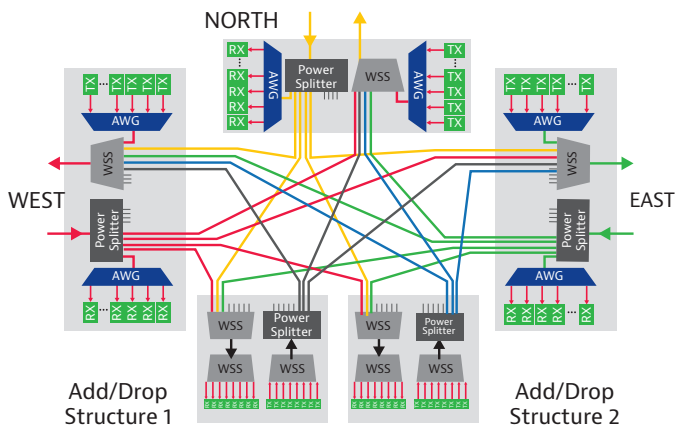

Deploying and Maintaining DWDM Metro and Core Networks Repeater

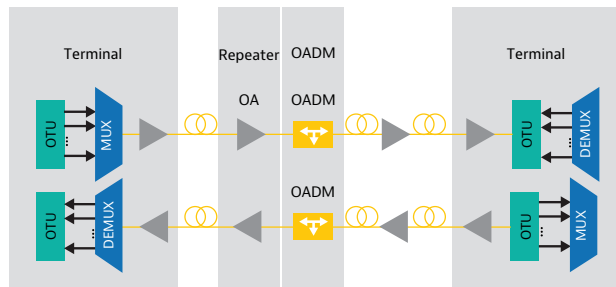

Testing 40 G and 100 G Interfaces and Networks

Spectral Testing of Optical Components

Monitoring CATV, Access, and Mobile Backhaul CWDM Systems

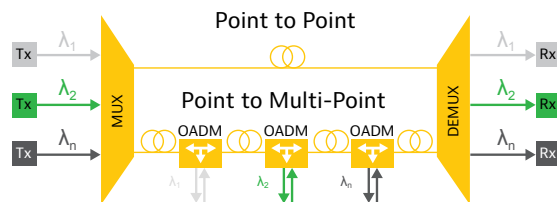
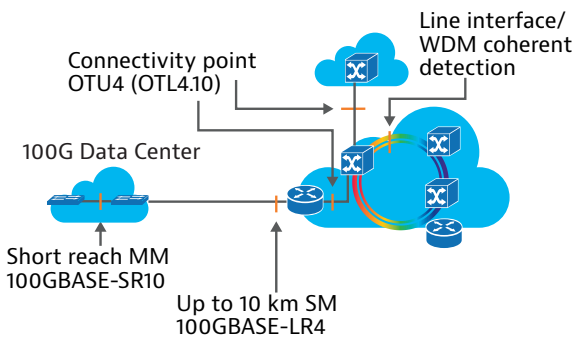

Transform your Technicians Into Instant OSA Experts

This easy-to-use OSA is key to successful WDM system deployment and maintenance. Spectral analysis can be challenging for technicians because of its complex instrument setup. Therefore, providers need a solution now more than ever that minimizes the need for training yet drives field efficiency and increases productivity.

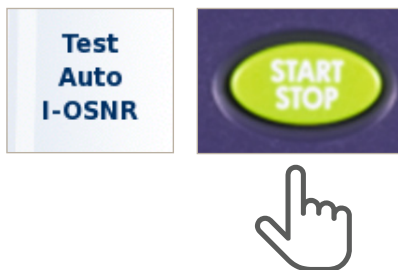

Step 1: Press Start

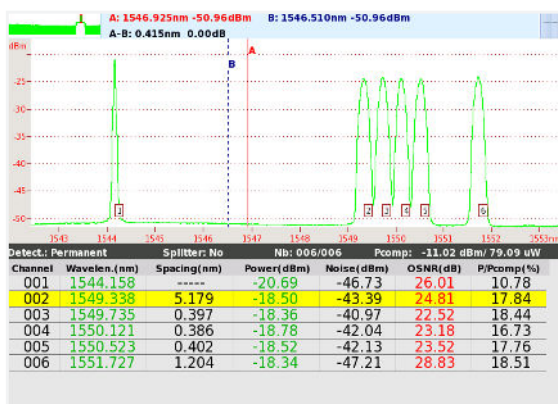

Step 2: Get Complete Test Result

Increase Field Efficiency with True OSNR Results in Any High-Speed or ROADM Network

OSAs are often used to measure OSNR for optical-layer service-performance analysis. Inaccurate OSNR measurements can lead to poorly estimated service performance.

As the graph shows, modern networks transporting densely spaced, high-data-rate signals can create overlapping spectral edges, which make it impossible to measure the noise floor between the signals and leads to underestimated OSNR.

Underestimated OSNR can indicate network problems in a perfectly fine network.

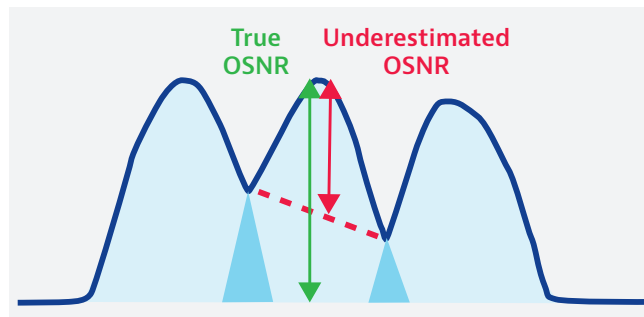

OSNR with Overlapping Spectra at 40G

Introducing ROADMs further complicates measuring OSNR with the conventional methods described in IEC 61280-2-9 and instead requires using new methods to measure in-band OSNR.

Instruments that only measure in-band noise at the spectral edges can significantly overestimate OSNR, as the graph shows.

Overestimating OSNR impedes the identification of network problems that degrade performance, increasing troubleshooting time and expense.

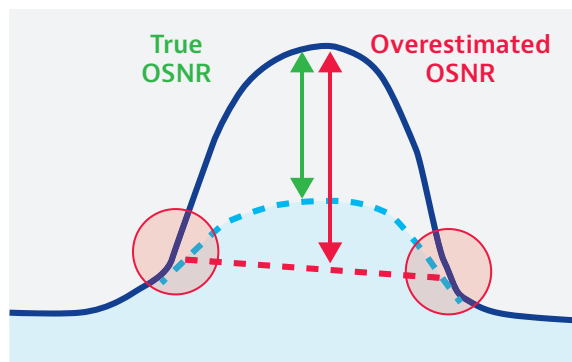

Noise shaping with ROADMs

Therefore, VIAVI developed a proprietary method for measuring OSNR within the signal bandwidth that shows the true in-band OSNR. Unlike other solutions, the VIAVI instrument measures and displays the noise distribution for the entire width of each DWDM channel to measure the signal's true OSNR.

Measure Confidently with a Self-Calibrating VIAVI OSA

The differences between a calibrated and an uncalibrated OSA are significant.

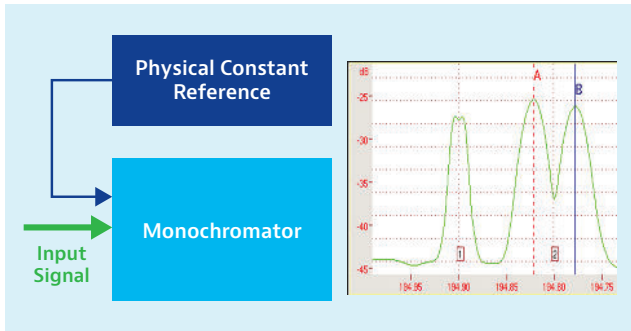

Excessive channel wavelength drift in DWDM systems can degrade performance and increase bit error rates because of high power attenuation in network elements such as multiplexers, demultiplexers, and ROADMs. Although it requires high wavelength accuracy, an OSA can detect this problem.

Even though many OSAs have an internal wavelength reference for calibration, they cannot guarantee the highest wavelength accuracy. The internal wavelength reference must be highly accurate regardless of changing environmental conditions or aging and, therefore, must be regularly recalibrated.

Only a physically constant reference can maintain internal wavelength accuracy without recalibration.

Guidelines:

- Instrument measurement accuracy should be better than 10 times the measurement limit.
- Absolute wavelength accuracy for a DWDM system with 50 GHz channel spacing should be ± 5 GHz = ± 40 pm.
- Absolute wavelength accuracy for a UDWDM system with 25 GHz channel spacing should be ± 2.5 GHz = ± 20 pm.

Inaccurate wavelength measurements can indicate that a channel is stable when in fact it is off frequency. Likewise, an unstable reference may indicate channel drift when in fact it is stable.

Uncalibrated OSA instruments can cause users to mistrust the system or the OSA.

Users can always trust the VIAVI OSA-500RS because of its internal physical constant wavelength calibrator.

You can now guarantee ± 10 pm optimal wavelength accuracy for a lifetime and cut calibration costs in half by eliminating recalibration.

Ordering Information

Description	Part Number
Standard OSA-500M	
OSA-500M, PC-version	2281/91.20
OSA-500M, APC-version	2281/91.30
Standard OSA-501M with 12.5 G Channel Drop	
OSA-501M, PC-version	2281/91.23
High Dynamic Range OSA-500	
OSA-500, PC-version	2281/91.51
ROADM, In-Band OSNR OSA-500R	
OSA-500R, PC-version	2281/91.55
OSA-500R, APC-version	2281/91.65
ROADM, High-Speed In-Band OSNR OSA-500RS	
OSA-500RS, PC-version	2281/91.57
OSA-500RS, APC-version	2281/91.67
Application Software for Report Generation	
Optical fiber trace software	EOFS100
Optical fiber cable software	EOFS200